









sanwa®

DCM2000DR

DIGITAL CLAMP METER

INSTRUCTION MANUAL 



Table of Contents

[1] SAFETY PRECAUTIONS – Before use, read the following safety precautions.–	
1-1 Explanation of Warning Symbols	1
1-2 Warning Messages for Safe Use	1
1-3 Overload Protection	3
[2] APPLICATIONS AND FEATURES	
2-1 Applications	4
2-2 Features	4
[3] NAMES OF COMPONENT UNITS	
3-1 Main unit and test leads	5
3-2 Display	6
[4] DESCRIPTION OF FUNCTIONS	
4-1 Power Switch & Function Switch	7
4-2 Auto power save	7
4-3 Low battery indication	7
4-4 Selecting the measurement function: SELECT button ...	7
4-5 BACK LIGHT function : SELECT () button	7
4-6 Range Hold: RANGE button	8
4-7 Measuring the relative value: ΔZERO button	8
4-8 Data Hold: HOLD button	8
4-9 Peak Hold: HOLD () button	8
4-10 EF (Electric Field) sensing: EF button	10
4-11 Muting the buzzer	10
4-12 AC Detection Method	10
4-13 Crest Factor	10
[5] MEASURING PROCEDURE	
5-1 Start-up Inspection	11
5-2  Auto low-impedance voltage/resistance detecting measurement (Auto Ω•V) ...	11
5-3  VFD (Variable Frequency Drive) AC voltage measurement ...	14
5-4  AC voltage measurement (ACV)	15
5-5  DC voltage / DC voltage + AC voltage measurement (DCV / DCV+ACV) ...	16
5-6  Current (A) measurements (ACA / DCA / DCA+ACA)	17
5-7  Resistance measurement / circuit continuity check (Ω / •)) ...	19
5-8  Capacitance measurement / Diode test (⇄ / ⇄)	20
5-9 EF (Electric Field) sensing	21
[6] MAINTENANCE	
6-1 Maintenance and Inspection	22
6-2 Calibration and Inspection	22
6-3 Storage	22
6-4 Battery Replacement	23
[7] AFTER-SALE SERVICE	
7-1 Warranty and Provision	24
7-2 Repair	24
7-3 SANWA web site	25
[8] SPECIFICATIONS	
8-1 General Specifications	26
8-2 Measuring ranges and accuracies	27

[1] SAFETY PRECAUTIONS

***Before use, read the following safety precautions.**

This instruction manual explains how to use your digital clamp meter equipped with the DMM facility DCM2000DR. Before use, please read this manual thoroughly to ensure correct and safe use. After reading it, keep it together with the product for reference to it when necessary. Using the product in a manner not specified in this manual may cause damage to the protection function of the product.

The instructions given under the headings of “ WARNING” and “ CAUTION” must be followed to prevent accidental burn and electric shock.

1-1 Explanation of Warning Symbols

The meanings of the symbols used in this manual and attached to the product are as follows:

 : **Very important instructions for safe use.**

- The warning messages are intended to prevent accidents to operating personnel such as burn and electric shock.
- The caution messages are intended to prevent incorrect handling which may damage the product.

 : Refer to Instruction Manual before use

 : High voltage hazard

 : Double or reinforced insulation

 : Direct current (DC)

 : Ground

 : Alternate current (AC)

 : Resistance

 : Circuit continuity buzzer

 : Diode

 : Capacitor

 : Backlight

 : EF antenna

 : Center position/Polarity indication

1-2 Warning Messages for Safe Use

WARNING

The following instructions are intended to prevent injury such as burn and electric shock. Be sure to follow them when using the meter:

1. This instrument is a low-voltage clamp meter equipped with the DMM facility. Do not use it with an electric circuit exceeding 1000 V.

2. Voltages over DC 70 V or AC 33 Vrms (46.7 V peak) are hazardous to human body. Take care so as not to touch them.
3. Never input signals exceeding the maximum rated input value (see 1-3).
4. Never use the meter for measuring voltages of lines connected to equipment (e.g. motors) that generates induced or surge voltage since it may exceed the maximum allowable overload input.
5. Never use the meter if the meter or test leads are damaged or broken.
6. Never use the meter with the case or battery lid removed.
7. During measurement, do not hold the instrument by a position on the test pin side of the barrier on the test probe or by a position beyond the barrier on the clamp sensor.
8. Do not switch the function in the middle of measurement.
9. Before performing measurement, make sure that the function and range are properly set.
10. Never use the meter when it is wet or with wet hands.
11. Never attempt repair or modification, except for battery replacement.
12. Perform start-up inspection and inspect the meter at least once a year.
13. This meter is for indoor use only.
14. Do not use the instrument in a method other than specified. Otherwise, the protection function may be spoiled.

 **CAUTION**

1. To avoid electric shock, always be sure to discharge the high voltage charged in the measured device after measuring insulation resistance.
2. Do not apply the voltage and current inputs simultaneously. Otherwise, malfunction will hinder accurate measurement.
3. Do not apply a strong force or impact to the clamp sensor section.

1-3 Overload Protection

Functions	Input terminals	Max. rated input	Max. overload protection input
$\frac{LoZ}{Auto}$ $\Omega \cdot V$ \cdot $\frac{Hz}{\sim}$ V \cdot $\frac{V}{\sim}$	- (Black), + (Red)	DC/AC 1000 V	DC/AC 1100 V
$\Omega^{(1)}$ \cdot $\frac{Hz}{\sim}$		Voltage input inhibited	DC/AC 1100 V
$\frac{Hz}{\sim}$ A	Clamp sensor section	DC/AC 2000 A	DC/AC 2000 A

[2] APPLICATIONS AND FEATURES

2-1 Applications

This instrument is an AC/DC clamp meter/digital multimeter of the RMS value response type, designed for measurements in the range specified by IEC 61010-1 CAT. IV, 1000 V.

It is suitable for current and voltage measurements of low-voltage circuitry, electric equipment and power supply facilities.

2-2 Features

- Safety design in compliance with the IEC61010-1.
- Clamp meter with DMM facility, designed for DC, AC and DC+AC measurements.
- AC measurement in true RMS value with simultaneous frequency display
- Auto power OFF (Can be disabled.)
- Convenient facilities including backlight, ZERO (relative value) display, Data Hold and Peak Hold.
- Low input impedance voltage measurement capable of attenuating the effects of ghost voltages
- VFD (Variable Frequency Drive) frequency measurement.
- EF (Electric Field) sensing.

Measurement Category (Overvoltage Category)

Measurement Category II (CAT. II):

Line on the primary side of equipment with power cord to be connected to the receptacle.

Measurement Category III (CAT. III):

Line from the primary side or branch of equipment which directly takes in electricity from a distribution board to the receptacle.

Measurement Category IV (CAT. IV):

Line from the service conductor to the distribution board.

[3] NAMES OF COMPONENT UNITS

3-1 Main unit and test leads

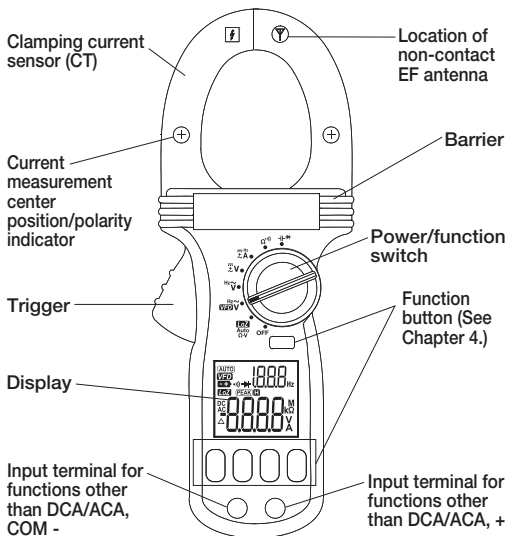

Test Leads

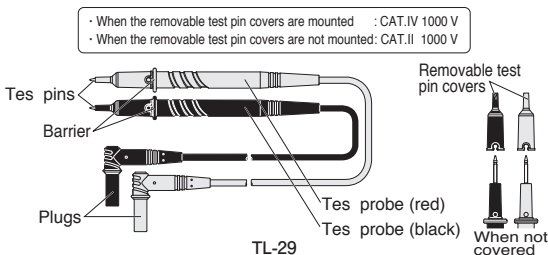

3-2 Display

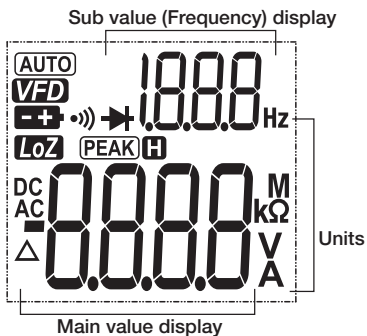

AUTO : Auto range

VFD : VFD

-+ : Low battery indication

PEAK : Peak measurement mode

•))) : Circuit continuity check

→+ : Diode

LoZ : Low input impedance

H : Data Hold

DC : Direct Current

AC : Alternate Current

- : Polarity (-)

Δ : Zero, relative value

[4] DESCRIPTION OF FUNCTIONS

4-1 Power Switch & Function Switch

Turn this switch to turn on and off the power and select a measuring function.

4-2 Auto power save

Auto power save reduces the battery power consumption by turning the display off automatically in about 34 minutes after the last operation made on this instrument. To recover from the mode set by Auto power save, press the **SELECT** button or the set the power switch to OFF then ON again.

*Auto power save can be disabled by turning the power/function switch to ON while holding the **SELECT** button depressed. The disabling of this mode is indicated by a short beep of the buzzer beeps and the change of the main value display from 8888 to 0000.











*A small current is flowing even when the display is turned off by Auto power save. After measurement, be sure to set the power/function switch to OFF.

4-3 Low battery indication

When the built-in batteries have been discharged and the voltage has dropped to below about 2.3 V, “” mark appears in the display. When this mark flickers or lights, replace both two batteries with new ones.

4-4 Selecting the measurement function: **SELECT** button

Press the **SELECT** button to switch the functions in one of the following sequences.

	: Auto → ACV → DCV → Ω → Auto
	: The SELECT button is disabled with these functions.
	: DCV → (DCV+ACV) → DCV
	: ACA → DCA → (DCA+ACA) → ACA
	: Ω →  → Ω
	:  →  → 

4-5 BACK LIGHT function : **SELECT** () button

When the **SELECT** button is held depressed (for more than 1 sec.), the display backlight is turned on. Holding the button depressed again turns the backlight off. The backlight also turns off automatically in 32 seconds after it is lit.

4-6 Range Hold: RANGE button

When the RANGE button is pressed, the meter is set in the manual mode and the range is fixed. (“AUTO” disappears from the display.) In the manual mode, each time this button is pressed, the range changes. While checking the unit and decimal point on the display, select the best range.

To return to the auto range, hold this button pressed for 1 second or longer. (“AUTO” appears on the display.) The backlight lighting is unavailable with the H function. The auto range can be used only with the frequency (Hz) display.

4-7 Measuring the relative value: Δ ZERO button

When the Δ ZERO button is pressed, Δ lights and the value assuming that the input value at the moment the button is pressed is 0 (reference value) is displayed. This mode is canceled when the button is pressed again. It is disabled with the frequency (Hz) display.

4-8 Data Hold: HOLD button

When the HOLD button is pressed, H lights and the value displayed at that moment is held. The display will not vary even when the measurement input varies. Pressing the button again extinguishes H and the Hold mode is canceled.

*The Hold mode is also canceled when the function switch position is changed or a button operation other than the backlight on operation is performed.

4-9 Peak Hold: HOLD (PEAK) button

When the HOLD button is held depressed (for more than 1 sec.) during the voltage or current measurement, PEAK lights on the display and the Peak Hold mode is started. Holding the button depressed again cancels the Peak Hold mode.

In the Peak Hold mode, the peak value of waveform is held at intervals of 5 msec. provided that the measurement input continues. The held value is not updated unless the input level exceeds the current value.

For instance, when the input is a 100 A sine wave AC, the peak value is about 141 A ($\sqrt{2}$ time the rated value).

- Almost the same values are displayed with both the AC and DC functions.
- Peak Hold does not work with the negative (-) input with both the AC and DC functions.

- When the **HOLD** button is pressed in the Peak Hold mode, **PEAK** and **H** light and the value displayed at that moment is held. Even the displayed value is held, the peak value continues to be updated internally so, when the **HOLD** button is pressed again to release the held value, the latest updated peak value is displayed.
- Auto range and Auto power save are disabled automatically in the Peak Hold mode. The Δ ZERO button is also disabled in this mode.
- The Peak Hold mode is canceled when the function switch is switched or the **SELECT**, **RANGE** or **EF** button is pressed.
- Examples of Peak Hold measurement:
- * The peak value of the negative (-) current is not held.

DC current peak

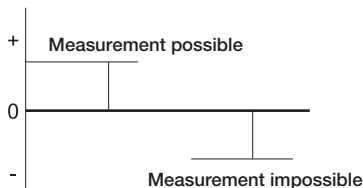

AC current peak

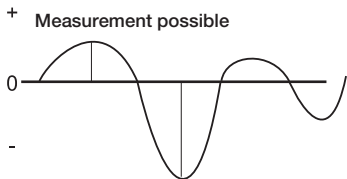

DC+AC current peak

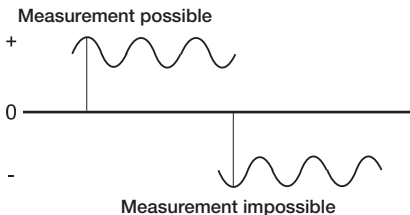

4-10 EF (Electric Field) sensing: EF button

For details, see section 5-9, "EF (Electric Field) sensing".

4-11 Muting the buzzer

Any buzzer sound can be muted by turning the power/function switch to ON while holding the **RANGE** button depressed. The muting of the buzzer sound is indicated by the change of the main value display from 8888 to 0000.

To cancel the buzzer muting, set the power/function switch to OFF then ON again.

*This cannot be performed at the same time as disabling of the Auto power save mode.

4-12 AC Detection Method

This meter employs the root-mean-square value method and indicates the magnitude of AC as the same amount of work as DC. Root-mean-square values of sinusoidal waves and such non-sinusoidal waves as square waves and chopping waves can be measured by the true RMS (Root Mean Square) circuit. (The input signal measurement value is used as the scale of the actual input signal power. It is therefore measured as a more effective value than the value obtained by average detection.)

4-13 Crest Factor

The CF (crest factor) indicates the peak value of a signal by dividing it by its root-mean-square value. With most common waveforms such as sinusoidal wave and chopping wave, the crest factor is low. With low duty cycle pulse waveforms, the crest factor is high. For the voltages and crest factors for typical waveforms, see the table below.

Please measure the crest factor by 3 or less.

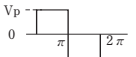
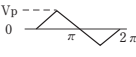
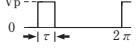
	Input Waveform	0 to PEAK V_p	Root Mean Square Value V_{rms}	Average Value V_{avg}	Crest Factor V_p/V_{rms}	Form Factor V_{rms}/V_{avg}
Sinusoidal wave		V_p	$\frac{V_p}{\sqrt{2}}$ =0.707 V_p	$\frac{2 V_p}{\pi}$ =0.637 V_p	$\sqrt{2}$ =1.414	$\frac{\pi}{2\sqrt{2}}$ =1.111
Square wave		V_p	V_p	V_p	1	1
Chopping wave		V_p	$\frac{V_p}{\sqrt{3}}$ =0.577 V_p	$\frac{V_p}{2}$ =0.5 V_p	$\sqrt{3}$ =1.732	$\frac{2}{\sqrt{3}}$ =1.155
Pulse		V_p	$\sqrt{\frac{\tau}{2\pi}} \cdot V_p$	$\frac{\tau}{2\pi} \cdot V_p$	$\sqrt{\frac{2\pi}{\tau}}$	$\sqrt{\frac{2\pi}{\tau}}$

Voltages of Various Waveforms

[5] MEASURING PROCEDURE

WARNING

1. Do not apply an input signal exceeding the maximum rated value of each function.
2. During measurement, do not change the function switch.
3. During measurement, do not touch the test pin side of the barrier of the test probe or the part past the barrier of the clamp sensor.
4. When measurement is finished, remove the clamp sensor (CT) and test lead from the object measured and return the function switch to the **OFF** position.
5. Use test leads matching the measurement category of the measured point.

5-1 Start-up Inspection

Check the following items before proceeding to measurement.



- Exterior check: Check the external view for irregularity caused by dropping, etc.
 - Check that the battery alarm  is not lit. If it is lit, replace the batteries with new ones.
 - Accessories: Check that the test leads are free of irregularity such as wire disconnection or crack.
 - Set the function switch to $\Omega^{(H)}$ and short the test pins to check that the test leads are free of wire disconnection.
 - Make sure that the main unit and hand are not wet with water, etc.
- *If the display shows nothing, the batteries may be exhausted completely.

5-2 Auto low-impedance voltage/resistance detecting measurement (Auto $\Omega \cdot V$)

WARNING

As the initial input impedance is as low as 2.5 k Ω , a high current flows through the measured circuit, which may exert adversary effects in measurements of a circuit with ground-fault interrupter or circuit/device with low current capacity. When measuring a voltage that requires high input impedance, be sure to use the $\overset{Hz}{\sim}V$, $\overset{Hz}{\sim}V$ or $\overset{Hz}{\sim}V$ function.

(For example, the initial max. load current in AC 1000 V measurement is high at 566 mA (1000 V x 1.414 / 2.5 k Ω) but the internal resistance is switched immediately so the load current drops to about 3.37 mA (1000 V x 1.414 / 420 k Ω).

Function	Input	Ranges
 DCV	±DC 1.500-1000 V	6.000/60.00/600.0/1000 V
 ACV	AC 1.500-1000 V	6.000/60.00/600.0/1000 V
 Ω	0.0 Ω - 10.00 MΩ	600.0/6.000 k/60.00 k/600.0 k /6.000 M/40.00 MΩ

*The accuracy-guaranteed frequencies of the  ACV measurement are from 50 to 60 Hz.

- ① Use the test leads for measurement.

This function measures the input by automatically identifying the type from the resistance (Ω), AC voltage (ACV) and DC voltage (DCV).

The low input impedance makes it possible to **reduce the effects of the ghost voltage** overlapped with the measuring target voltage. The ghost voltage refers to the voltage induced from adjacent wires and unnecessary floating signals.

- ② Standby mode

When no input is applied, the main value display of the LCD shows “Auto”.

- ③ Identification conditions

- When the input voltage is higher than 1.5 V, this function automatically identifies whether the input type is AC voltage (ACV) or DC voltage (DCV) and displays it.

*When DCV and ACV are superimposed, the value of the signal with the higher crest value is displayed.

- When there is no input voltage and the resistance is below 10 MΩ, this function displays the resistance value. The buzzer beeps if the resistance is lower than the threshold (20 to 200 Ω).

- ④ Low input impedance

- Applying a high voltage to input impedance of hundreds of kΩ has a potential of causing a problem. This is the reason that  is displayed to notice the user of the low input impedance mode.
- When the displayed voltage value is about 50 V or more, the input impedance is switched instantaneously to one of the following values.

1.5-50 V: 2.5 kΩ. 50-100 V: 10 kΩ. 100-300 V: 60 kΩ. 300-600 V: 200 kΩ. 600-1000 V: 420 kΩ.

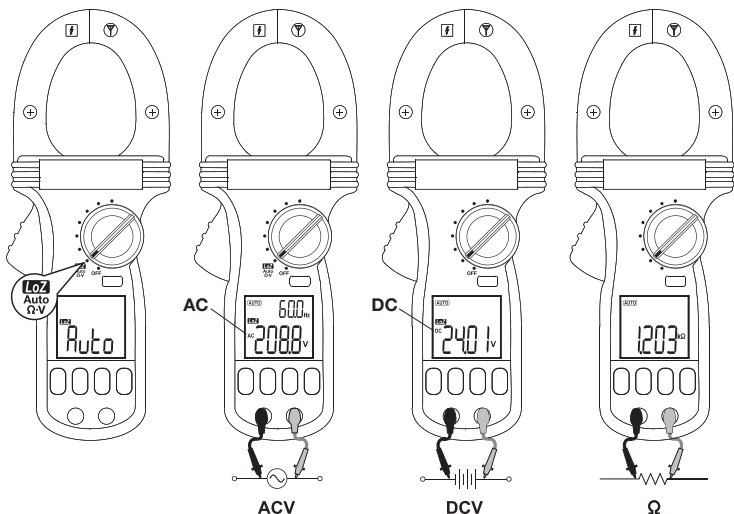

Notes:

- The fixed function can be selected with the **SELECT** button. The auto identification mode can be confirmed with [**Auto**] lit on the main value display when there is no input signal.
- When the **RANGE** button is pressed once while a measurement value is displayed, the current function (Ω , DCV or ACV) and range are fixed and the instrument is put to the manual range mode (**AUTO** extinguished).

The range can be switched by pressing the button again. Holding the button depressed for more than 1 sec. lights **AUTO** and the instrument enters the auto range mode, but the function is still fixed.

- Auto identification is disabled in the manual range and fixed function mode. Note that, when the instrument is set to the resistance function and manual range mode, the function is not switched automatically to the voltage function even when a voltage is input.

5-3 $\overset{\text{Hz}\sim}{\text{VFD}}\text{V}$ VFD (Variable Frequency Drive) AC voltage measurement

WARNING

This function uses a low-pass filter to cut high frequencies. As there is a possibility that a voltage higher than the displayed value exists, first measure the voltage with $\overset{\text{Hz}\sim}{\text{V}}$ to confirm that there is no hazardous voltage before selecting the $\overset{\text{Hz}\sim}{\text{VFD}}\text{V}$ function.

Function	Input	Ranges
$\overset{\text{Hz}\sim}{\text{VFD}}\text{V}$ ACV	0.000 ~ 1000 V	6.000/60.00/600.0/1000 V
$\overset{\text{Hz}\sim}{\text{VFD}}\text{V}$ Hz	10.0 ~ 400 Hz	199.9/1999 Hz

*The accuracy-guaranteed frequencies of this measurement are from 10 to 400 Hz.

*The filter characteristic is 0.9 kHz, at about -3 dB.

- ① Use the test leads for measurement.
- ② A drive voltage with which the noise in the carrier frequency is cut using a sine wave synthesized with an inverter can be measured. (Low-pass filter)
- ③ The frequency (Hz) input sensitivity is determined by the range being used for display. A different input sensitivity can also be selected manually by pressing the RANGE button. If the Hz value becomes unstable, select a higher voltage range to avoid the effects of electrical noise. If the Hz value is null, select a lower voltage range.
- ④ The auto range switching is for the 600/1000 V ranges. The range switching of the 6/60 V ranges is manual.

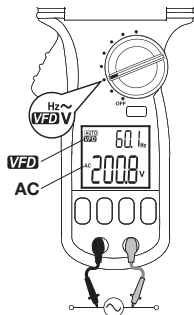

5-4 $\text{Hz}\sim\text{V}$ AC voltage measurement (ACV)

Function	Input	Ranges
$\text{Hz}\sim\text{V}$ ACV	0.000 ~ 1000 V	6.000/60.00/600.0/1000 V
$\text{Hz}\sim\text{V}$ Hz	40.0 ~ 1999 Hz	199.9/1999 Hz

- ① Use the test leads for measurement.
- ② The frequency (Hz) input sensitivity is determined by the range being used for display. A different input sensitivity can also be selected manually by pressing the RANGE button. If the Hz value becomes unstable, select a higher voltage range to avoid the effects of electrical noise. If the Hz value is null, select a lower voltage range.

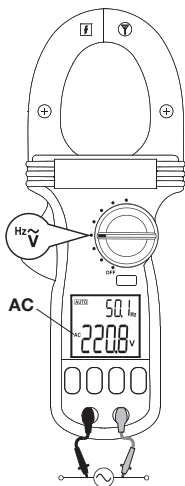

5-5 $\overline{\text{V}}$ DC voltage / DC voltage + AC voltage measurement (DCV/ DCV+ACV)

Function	Input	Ranges
$\overline{\text{V}}$ DCV	$\pm 0.000\text{--}1000\text{ V}$	6.000/60.00/600.0/1000 V
$\overline{\text{V}}$ DCV+ACV	0.000-1000 V	6.000/60.00/600.0/1000 V
$\overline{\text{V}}$ Hz	10.0-1999 Hz	199.9/1999 Hz

*The frequency is not displayed when DCV is more than 50 % of ACV.

- ① Use the test leads for measurement.
- ② Each press of the **SELECT** button switches the function in sequence of: DCV \rightarrow (DCV+ACV) \rightarrow DCV.

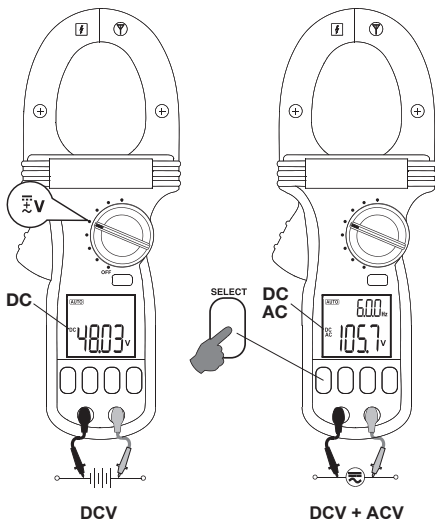

5-6 $\overline{\sim}$ Hz $\overline{\sim}$ A Current (A) measurements (ACA/DCA/DCA+ACA)

CAUTION

1. To improve the measurement accuracy, position the measured conductor as close as possible to the center of the clamp sensor.
2. Always clamp around a single wire at a time. Correct current measurement is impossible if multiple wires, a cable with multiple conductors or parallel cords are clamped.
3. Correct measurement may be impossible if the clamp sensor is not closed completely.
4. Malfunction may occur if the instrument is used in a strong electromagnetic field.
5. When the 0 adjustment is performed by pressing the Δ ZERO button during the DC current (DCA) function measurement, the displayed value may vary by a few counts due to the reason described above, but this is not malfunction. The 0 adjustment should be performed after the orientation of the instrument has been changed (because of the effects of external magnetic field or terrestrial magnetism) or when the temperature change is large.

- ① Use the clamp sensor for measurement.
- ② Each press of the SELECT button switches the function in sequence of: ACA \rightarrow DCA \rightarrow (DCA+ACA) \rightarrow ACA.

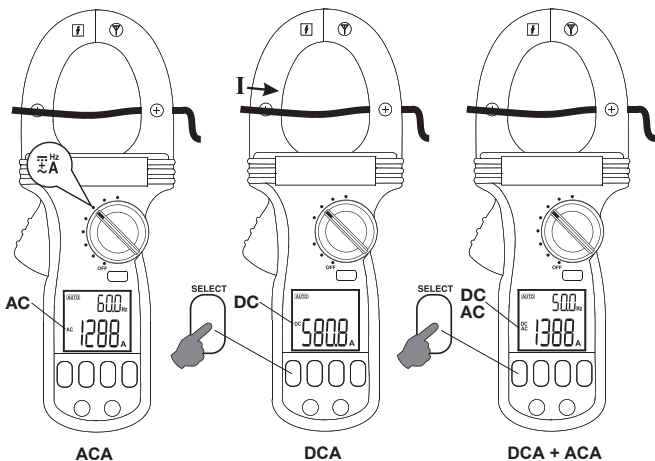

5-6-1 AC current measurement (ACA)

Function	Input	Ranges
ACA	0.0-2000 A	200.0/2000 A
Hz	20.0-400 Hz	199.9/1999 Hz

*The accuracy-guaranteed frequencies of this measurement are from 40 to 400 Hz.

- ① Press the **SELECT** button so that **AC** lights.
- ② Open the clamp sensor, position the wire to be measured and close the clamp sensor completely.
- ③ Read the displayed value.

Note:

When the clamp sensor is opened/closed or the function is switched, a count of some tens is displayed temporarily. This display returns to 0 after taking certain time because of the RMS response, but there will not be problem in the measurement value even if the measurement is started before the display returns to 0.

5-6-2 DC current measurement (DCA)

Function	Input	Ranges
DCA	±0.0-2000 A	200.0/2000 A

- ① Press the **SELECT** button so that **DC** lights.
- ② Wait until the display stabilizes, then press the **ΔZERO** button to perform the 0 adjustment. (**Δ** lights on the LCD display.)
- ③ Open the clamp sensor, position the wire to be measured and close the clamp sensor completely.
- ④ Read the displayed value.

*Align the orientation of the arrow on the side of the clamp sensor with the orientation of the measured current. If they are not aligned, the displayed polarity becomes - (negative).

5-6-3 DC current + AC current measurement (DCA+ACA)

Function	Input	Ranges
DCA + ACA	0.0-2000 A	200.0/2000 A
Hz	20.0-400 Hz	199.9/1999 Hz

*The frequency is not displayed when DCV is more than 50 % of ACV.

- ① Press the **SELECT** button so that both DC and AC light.
- ② Wait until the display stabilizes, then press the **ΔZERO** button to perform the 0 adjustment. (**Δ** lights on the LCD display.)
- ③ Open the clamp sensor, position the wire to be measured and close the clamp sensor completely.
- ④ Read the displayed value.

5-7 Ω Resistance measurement / circuit continuity check (Ω / ∩))

⚠ WARNING

Never apply an external voltage to the measurement terminals.

Function	Input	Ranges
Ω	0.0 Ω - 40.00 MΩ	600.0/6.000 k/60.00 k/600.0 k /6.000 M/40.00 MΩ
∩))	0.0-600.0 Ω	600.0 Ω

*The open voltage between the input terminals is about 0.5 V.

- ① Use the test leads for measurement.
- ② Each press of the **SELECT** button switches the function in sequence of : Ω → ∩)) → Ω → ...

With ∩)) , the buzzer beeps when the resistance is below the threshold (10-200 Ω).

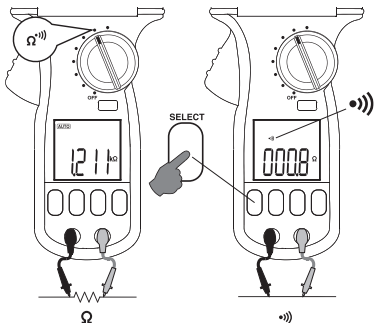

5-8 $\leftarrow \rightarrow$ Capacitance measurement / Diode test ($\leftarrow \rightarrow$ / $\rightarrow \leftarrow$)

WARNING

Never apply an external voltage to the measurement terminals.

CAUTION

1. Discharge the measured capacitor before measurement.
2. Since this instrument measures the capacitance by applying current to the measured capacitor, it is not suitable for measuring a capacitor with high leak current such as an electrolytic capacitor.

Function	Input	Ranges
$\leftarrow \rightarrow$	0.00 nF ~ 2000 μ F	60.00 n/600.0 n/6.000 μ /60.00 μ /600.0 μ /2000 μ F
$\rightarrow \leftarrow$	0.000 ~ 1.000 V	—

*The open voltage of the diode test is about 1.8 V

- ① Use the test leads for measurement.
- ② Each press of the **SELECT** button switches the function in sequence of $\leftarrow \rightarrow \rightarrow \leftarrow \rightarrow \leftarrow \rightarrow \dots$

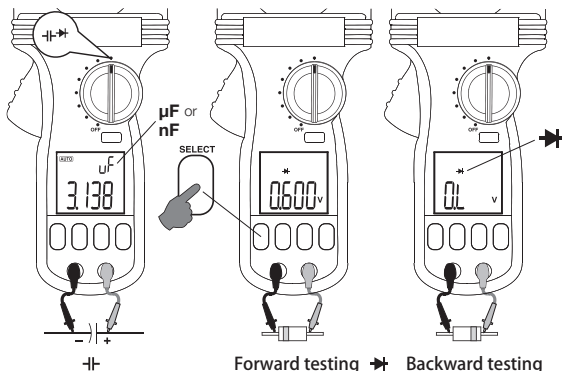

Non-defective cases:
Forward voltage, drop
display
Defective cases: 0.000 V
display, OL display

Non-defective cases:
OL display
Defective cases: Other
display

5-9 EF (Electric Field) sensing

⚠ CAUTION

1. Before EF sensing, check the operation of the instrument using a known power source.
2. During EF sensing, do not hold the instrument by a position beyond the barrier.
3. Even when no voltage is sensed, this does not always mean that no voltage exists because a voltage below the sensing threshold may exist.

- ① The EF sensing judges the presence of electrical voltage in a simplified manner by detecting the electrical field produced by AC voltage.
- ② When the **EF** button is pressed while a function other than voltage or current (other than Ω) or $\text{--}|\text{+}$ is selected, the EF sensing is activated and “E.F.” lights on the main value display of the LCD panel. The EF sensing is canceled by pressing the **EF** button or changing the function switch position.
- ③ The signal intensity is displayed by segments such as “- - -”. The interruption intervals of the buzzer beep also changed. The higher the sensed voltage, the number of displayed “-” increases and the buzzer beeps at shorter intervals.

④ Antenna

- Non-contact sensing: The antenna is located in the proximity of the Y marking on the clamp sensor.
- Contact sensing: Bring the test pin of the test lead connected to the * measurement terminal in contact. This method is capable of more accurate sensing by identifying the non-grounded and grounded sides, etc. The display shows “-” and the buzzer beeps with the non-grounded (Hot) side, while the display remains “E.F.” and the buzzer does not beep with the grounded side.

*“E.F.” that should be displayed with the grounded site may become “-” when the wiring is long, etc.

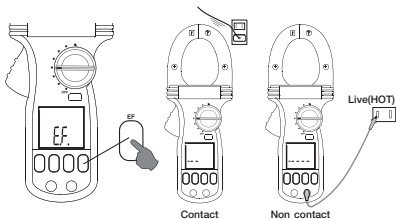

Notes:

- If the area around the Y marking on the clamp sensor is brought in contact with a non-grounded cabinet of equipment or touched by hand, the “-” display and the buzzer beep may sometimes appear.
- Due to the high sensitivity, the EF sensing may be activated near an inverter generating high frequencies, even when it is as apart as more than some tens of centimeters from the instrument.

[6] MAINTENANCE

WARNING

1. The following instructions are very important for safety.
Read this manual thoroughly to ensure correct maintenance.
2. Calibrate and inspect the meter at least once a year to ensure safety and maintain its accuracy.

6-1 Maintenance and Inspection

- 1) Appearance: Is the meter not damaged due to falling or other cause?
- 2) Test leads:
 - Are the core wires not damaged or exposed from the test leads?
 - Is the plug when inserted to the input terminal not loose?If any of the above problems exists, stop using the meter and request for repair.

6-2 Calibration and Inspection

For more information, please contact Sanwa's authorized agent / distribute service provider, listed in our website.
See section 7-3.

6-3 Storage

CAUTION

1. The panel and case are not resistant to volatile solvent and must not be cleaned with thinner or alcohol.
2. The panel and case are not resistant to heat. Do not place the meter near heat-generating devices.
3. Do not store the meter in a place where it may be subjected to vibration or where it may fall.
4. Do not store the meter in places under direct sunlight, or hot, cold or humid places or places where condensation is anticipated.
5. If the meter will not be used for a long time, remove the batteries.

6-4 Battery Replacement

Batteries when the meter is shipped:

A battery for monitoring has been installed prior to shipment from the factory. It may be discharged before the expiration of the described battery life.

*The battery for monitoring is a battery used to check the functions and performance of the product.

WARNING

1. To avoid electric shock, do not remove the battery holder cover with an input being applied to the measuring terminals or clamp sensor or during measurement.
2. Make sure that the power/function switch is set to OFF before proceeding to the battery replacement.

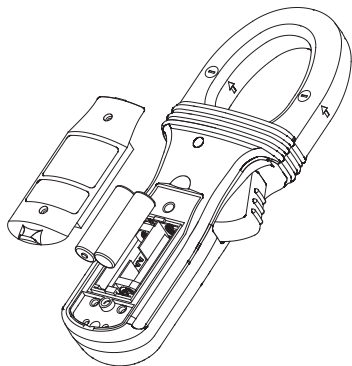

- ① Using a screwdriver, loosen the two screws retaining the battery holder cover.
- ② Remove the floated battery holder cover.
- ③ Replace both of the two batteries in the battery holder by observing the correct polarity.
- ④ Tighten the battery holder retaining screws in the original positions.

[7] AFTER-SALE SERVICE

7-1 Warranty and Provision

Sanwa offers comprehensive warranty services to its end-users and to its product resellers. Under Sanwa's general warranty policy, each instrument is warranted to be free from defects in workmanship or material under normal use for the period of one (1) year from the date of purchase.

This warranty policy is valid within the country of purchase only, and applied only to the product purchased from Sanwa authorized agent or distributor.

Sanwa reserves the right to inspect all warranty claims to determine the extent to which the warranty policy shall apply. This warranty shall not apply to disposables batteries, or any product or parts, which have been subject to one of the following causes:

1. A failure due to improper handling or use that deviates from the instruction manual.
2. A failure due to inadequate repair or modification by people other than Sanwa service personnel.
3. A failure due to causes not attributable to this product such as fire, flood and other natural disaster.
4. Non-operation due to a discharged battery.
5. A failure or damage due to transportation, relocation or dropping after the purchase.

7-2 Repair

Customers are asked to provide the following information when requesting services:

1. Customer name, address, and contact information
2. Description of problem
3. Description of product configuration
4. Model Number
5. Product Serial Number
6. Proof of Date-of-Purchase
7. Where you purchased the product

Please contact Sanwa authorized agent / distributor / service provider, listed in our website, in your country with above information. An instrument sent to Sanwa / agent / distributor without above information will be returned to the customer.

Note:

- 1) Prior to requesting repair, please check the following:
Capacity of the built-in battery, polarity of installation and discontinuity of the test leads.
- 2) Repair during the warranty period:
The failed meter will be repaired in accordance with the conditions stipulated in 7-1 Warranty and Provision.
- 3) Repair after the warranty period has expired:
 - If it is expected that servicing can restore the original functioning of the instrument, we will service it for a price upon request of the user.
 - The service charge or transport freight could sometimes become higher than the product price. Please consult us before asking for servicing.
 - The minimum retention period of the servicing performance parts of this instrument is six (6) years after the discontinuation of production. This period is equal to the servicing available period. However, the retention period of a part may be reduced if it becomes unavailable due to discontinuation of production of the part manufacturer, etc.
- 4) Precautions when sending the product to be repaired
To ensure the safety of the product during transportation, place the product in a box that is larger than the product 5 times or more in volume and fill cushion materials fully and then clearly mark "Repair Product Enclosed" on the box surface. The cost of sending and returning the product shall be borne by the customer.

7-3 SANWA web site

<http://www.sanwa-meter.co.jp>

E-mail: exp_sales@sanwa-meter.co.jp

[8] SPECIFICATIONS

8-1 General Specifications

Operation method	Δ - Σ method
AC detection method	True RMS
Display	Main value: Max. 6000 count Sub value (frequency): Max. 1999 count
Sampling rate	Approx. 5 times/sec.
Over-range display	"OL" is displayed
Range switching	Auto, manual
Polarity switching	Auto (Only "-" is displayed.)
Low battery indication	The  indicator lights on the display when the supply voltage from the internal batteries drops below about 2.3 V.
Current measurement method	Clamp type current sensor (CT)
Clamp opening diameter	Max. about ϕ 55 mm
Operating environmental conditions	Altitude no more than 2000 m, indoor use, environmental pollution degree II
Operating temperature/humidity ranges	Temperature: 5 to 40 °C. Humidity is as follows (without condensation). 5 to 31 °C: Max. 80 %RH. 31 to 40 °C: Linearly decreases from 80 %RH to 50 %RH.
Storage temperature/humidity ranges	Temperature -10 to +40 °C: No more than 80 %RH, without condensation. Temperature +40 to +50 °C: No more than 70 %RH, without condensation. (Remove the internal batteries when the instrument is not to be used for long time.)
Temperature coefficient	At below 18 °C or above 28 °C, Multiply accuracy by x0.15 per 1 °C. (The coefficient is x0.25 with the \div function.)
Power supply	"AA" size battery (R6) 1.5 V x 2
Auto power save	Power save mode is activate in approx. 34 min. after the last operation. TYP. 10 μ A
Current consumption	Approx. 14 mA TYP. (A function) Approx. 5 mA TYP. (Functions other than A)
Battery life	Approx. 80 hours (A function) Approx. 240 hours (Functions other than A) *Life when the backlight is off.

Dimensions/weight	H264×W97×D43 mm / approx. 640 g (including batteries)
Safety standards	IEC61010-1, IEC61010-2-030 CAT. IV 1000 V, IEC61010-2-32, IEC61010-31
EMC directive	IEC61326-1 Environment under 3 V/m field intensity: Accuracy not guaranteed with the capacitance measurement function. Specified accuracy ± 200 dgt. with other functions. Environment under over 3 V/m field intensity: Accuracy not guaranteed.
Accessories	Instruction manual, test leads (TL-29), carrying pouch (C-DCM2000DR)

8-2 Measuring ranges and accuracies

Accuracy-guaranteed temperature/humidity ranges: 23 \pm 5 °C, no more than 80 %RH (without condensation)

rdg: Reading. dgt: Lowest digit.

Because of the RMS response, the accuracy-guaranteed range and crest factor (CF) are as follows.

Range: 5 % to 100 % of measuring range.

CF: Full-scale CF < 1.4

Half-scale CD < 2.8

DCV (DC voltage)

Ranges	Accuracy
6.000 / 60.00 / 600.0 / 1000 V	\pm (0.5 %rdg + 5 dgt)

Note: The input impedance is about 10 M Ω at 50 pF.

⚡ (AUTO Ω V) DCV (DC voltage)

Ranges	Accuracy
6.000 / 60.00 / 600.0 / 1000 V	\pm (1.3 %rdg + 5 dgt)

Note: **⚡** DCV threshold is DC 1.5 V or more or DC -1.5 V or less.

The initial input impedance is about 2.5 k Ω at 600 pF. When the displayed voltage is about 50 V or higher, the input impedance is switched instantaneously.

1.5-50 V: 2.5 k Ω . 50-100 V: 10 k Ω . 100-300 V: 60 k Ω .

300-600 V: 200 k Ω . 600-1000 V: 420 k Ω .

ACV (AC voltage): The frequency is from 50 to 400 Hz.

Ranges	Accuracy
6.000 / 60.00 / 600.0 / 1000 V	\pm (1.2 %rdg + 5 dgt)

Note: The input impedance is about 10 M Ω at 50 pF.

DCV+ACV (DC voltage + AC voltage): The AC frequency is from 50 to 400 Hz.

Ranges	Accuracy
6.000 / 60.00 / 600.0 / 1000 V	$\pm(1.4 \%rdg + 7 dgt)$

Note: The input impedance is about 10 M Ω at 50 pF.

LoZ (AUTO Ω V) ACV (AC voltage): The frequency is from 50 to 60 Hz

Ranges	Accuracy
6.000 / 60.00 / 600.0 / 1000 V	$\pm(1.5 \%rdg + 5 dgt)$

Note: **LoZ** ACV threshold is 1.5 V AC or more.

The initial input impedance is about 2.5 k Ω at 600 pF. When the displayed voltage is about 50 V or higher, the input impedance is switched instantaneously.

1.5-50 V: 2.5 k Ω . 50-100 V: 10 k Ω . 100-300 V: 60 k Ω .

300-600 V: 200 k Ω . 600-1000 V: 420 k Ω .

VF D ACV (AC voltage): Low-pass filter is applied.

Ranges	Frequency	Accuracy
6.000 / 60.00 / 600.0 / 1000 V	10-20 Hz	$\pm(4.0 \%rdg + 80 dgt)$
	20-200 Hz	$\pm(2.0 \%rdg + 60 dgt)$
	200-400 Hz	$\pm(7.0 \%rdg + 80 dgt)$

Note: The filter characteristic is 0.9 kHz, at about -3 dB.

- The accuracy decreases linearly from 200 Hz (2 % + 60 dgt) to 400 Hz (7 % + 80 dgt).

DCA (DC current)

Ranges	Accuracy
200.0 A	$\pm(2.0 \%rdg + 5 dgt)$
2000 A 0-500 A	$\pm(2.0 \%rdg + 5 dgt)$
2000 A 501-2000 A	$\pm(3.0 \%rdg + 5 dgt)$

Note: Accuracy after the zero point is set by pressing the Δ ZERO button.

ACA (AC current)

Ranges	Frequency	Accuracy
200.0 A	50-60 Hz	$\pm(2.0 \%rdg + 5 dgt)$
2000 A 0-500 A		$\pm(2.5 \%rdg + 5 dgt)$
2000 A 501-2000 A		$\pm(3.0 \%rdg + 5 dgt)$
200.0 A	40-49.9 Hz 60.1-400 Hz	$\pm(2.5 \%rdg + 5 dgt)$
2000 A 0-500 A		$\pm(3.0 \%rdg + 5 dgt)$
2000 A 501-1000 A		$\pm(3.5 \%rdg + 5 dgt)$
2000 A 1001-2000 A		Not specified

DCA+ACA (DC current + AC current)

Ranges	Frequency	Accuracy
200.0 A	DC or 50-60 Hz	$\pm(3.0 \text{ \%rdg} + 8 \text{ dgt})$
2000 A		
200.0 A	40-49.9 Hz 60.1-400 Hz	$\pm(3.5 \text{ \%rdg} + 5 \text{ dgt})$
2000 A 0-1000 A		
2000 A 1001-2000 A		Not specified

Note: Accuracy after the zero point is set by pressing the Δ ZERO button.

Peak Hold

When the waveform width is 5 msec, or more, add ± 250 dgt to the accuracy.

Hz (Frequency)

Ranges	Input sensitivity	Measurable frequency	Accuracy
6.000 V	2 V	40.0-1999 Hz	$\pm(0.1\% \text{rdg} + 4 \text{ dgt})$
60.00 V	20 V		
600.0 V	100 V		
1000 V	600 V		
VFD 6.000 V	0.6-2.3 V	10.0-400 Hz	
VFD 60.00 V	6-24 V		
VFD 600.0 V	60-240 V		
VFD 1000 V	600 V	10.0-200 Hz	
200.0 A	10 A	20.0-400 Hz	
2000 A	100 A		

Note: The input sensitivity is specified as the RMS value of the sine wave. The sensitivity of **VFD** decreases linearly from 10 % (at 200 Hz) to 40 % (at 400 Hz) of the full scale.

*The frequency is displayed when the DC component is less than 50 % of ACrms.

*In the 1000 V range, the frequency is displayed when the DC component is less than 100 V.

Ω , **LoZ** Ω (Resistance)

Ranges	Accuracy
600.0 Ω / 6.000 k Ω / 60.00 k Ω	$\pm(0.5 \text{ \%rdg} + 5 \text{ dgt})$
600.0 k Ω	$\pm(0.8 \text{ \%rdg} + 5 \text{ dgt})$
6.000 M Ω	$\pm(1.2 \text{ \%rdg} + 5 \text{ dgt})$
40.00 M Ω	$\pm(2.3 \text{ \%rdg} + 5 \text{ dgt})$

Note: The open voltage is about DC 0.45 V.

• With the **LoZ** function, the resistance is displayed when it is below about 10 M Ω .

))) Circuit continuity check

The buzzer beeps at below the threshold (10 to 200 Ω).

Response time: Approx. 32 msec.

+- Capacitance

Ranges	Accuracy
60.00 nF / 600.0 nF / 6.000 μ F	$\pm(2.0\% \text{rdg} + 5 \text{dgt})$
60.00 μ F / 600.0 μ F	$\pm(3.5\% \text{rdg} + 5 \text{dgt})$
2000 μ F	$\pm(4.0\% \text{rdg} + 5 \text{dgt})$

Note: Accuracy applicable to capacitors with low leak current equivalent to or lower than the film capacitor.

➔ Diode

Ranges	Accuracy
1.000 V	$\pm(1.0\% \text{rdg} + 3 \text{dgt})$

Note: The open voltage is about 1.8 V DC or less, and the measurement current is about 0.56 mA.

EF (Electric Field) sensing

A voltage or electric field of about 60 V or more is detected.

The bar graph and intermittent buzzer beeps change in three steps according to the field intensity.

Sensing frequency: 50/60 Hz

Sensing antenna: Area around the $\text{\textcircled{Y}}$ marking on the clamp sensor.

Contact type EF sensing: + terminal test lead.

Accuracy calculation method

Example) ACV (AC voltage) measurement

Displayed value: 100.0 V

Range and accuracy: $\pm(1.2\% \text{rdg} + 5 \text{dgt})$ in 600.0 V range

Error: $\pm(100.0 \text{ V} \times 1.2\% + 5 \text{dgt}) = \pm 1.7 \text{ V}$

True value: 100.0 V $\pm 1.7 \text{ V}$ (98.3 to 101.7 V)

* In the 600.0 V range, the 5 dgt corresponds to 0.5 V.

The product specifications described in this manual and its appearance are subject to change without notice for improvement or other reasons.

MEMO

sanwa®

三和電気計器株式会社

本社=東京都千代田区外神田2-4-4・電波ビル

郵便番号=101-0021・電話=東京(03)3253-4871(代)

大阪営業所=大阪市浪速区恵美須西2-7-2

郵便番号=556-0003・電話=大阪(06)6631-7361(代)

SANWA ELECTRIC INSTRUMENT CO.,LTD.

Dempa Bldg., 4-4 Sotokanda2-Chome Chiyoda-Ku, Tokyo, Japan



大豆インキを使用しています。

This manual emplys soy ink.

01-1310 2040 6010